



We Build the Invisible

BATIMAT 2022



Member of
**SIMONSWERK
GROUP**



We Build the Invisible

▪ SINCE 1938 WE INNOVATE...

CLASSIC®

DECOR®

CONSTRUCT®

SABCO®
SADEV BALUSTRADE CONCEPT

OSF®

ROMEO CARE®
GARDE-CORPS POUR FENÊTRES

SWIMSIDE®

INO®

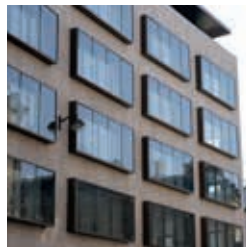
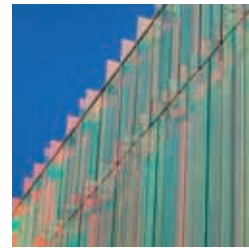
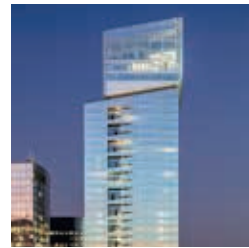
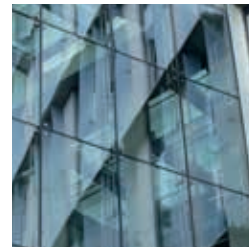

BECAUSE OUR ONLY LIMIT
IS YOUR IMAGINATION.

THE LATEST INNOVATIONS OF OUR RANGES

ROMEO CARE

THE JULIET BALCONY RAILING

French balcony solution

P > 05



VARIANCE P[®]

Fastening system for glass cladding

P > 09



OSF[®]

Glass railing

P > 13



SABCO[®]

SADEV BALUSTRADE CONCEPT

Glass railing

P > 17



THE FRENCH BALCONY RAILING THAT CAN BE INSTALLED IN 1 CLICK



SYSTEM FEATURES:

- Revolutionary ease of installation with the **OPC system**, 1-click installation!
- **Compact design** to fit into the building's architecture.
- **Sold in kits:** 500, 700, 900, 1000, 1100 and 1200mm.
- **Length of 6 000mm possible**, for storage.
- **Can be installed on any support** (PVC, aluminum, wood or metal).
- **Several RAL finishes available**, to match the colors of the building or the window.
- Glass width **from 1 000 to 3 000mm**.
- **Test reports available**.
- **Integrated drainage**.

DOWNLOAD
the brochure



UNIQUE EASE OF INSTALLATION ON THE MARKET

Quick and easy assembly by one person!

OPC SYSTEM

Open - Position - Clip.... **is finished!**

STEP
1

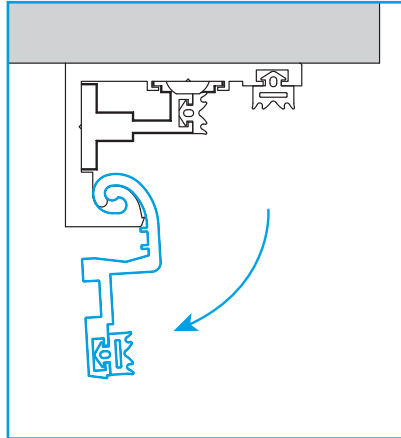

> **Open** by turning the pivoting part.

STEP
2

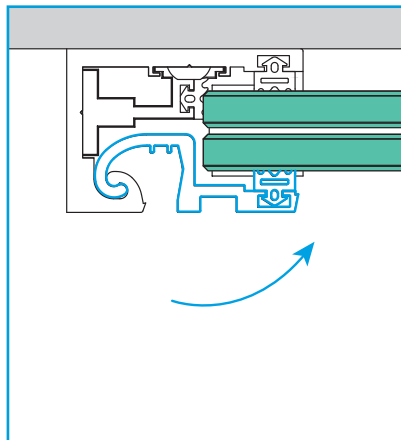

> **Position** the glass and close the pivoting part. The glass is held!

STEP
3

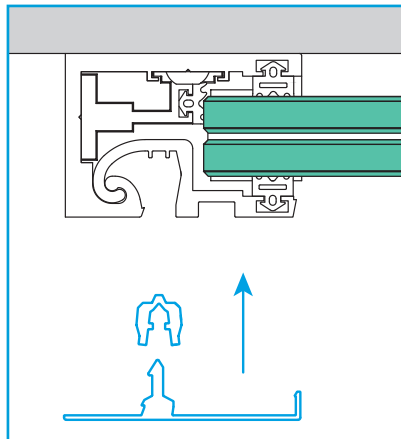

> **Clip** the cover.

2 TYPES OF ASSEMBLIES

- Profiles in kit from **500mm to 1200mm**
- Glass thickness from **10 to 21.52mm**
- **6 m long profile for storage available**
- **Several finishes adaptable** according to RAL

Compatible with structures

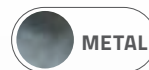
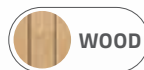

SIDE MOUNT

Fixation on the window frame



TOP MOUNT

Fixation on the facade



ANODIZED ALUMINUM
Code: **01**



ALUMINIUM BRUSHED
STAINLESS STEEL EFFECT
Code: **02**



RAL COLOUR
Code: **03**

No less than 3 patents on this system

GLASS CLADDING SYSTEM

VARIANCE P is a **patented fixing system, for glass cladding** (composite or BEFUP possible) allowing to realize the glass cladding of simple or complex facades.

Its hook system saves **a lot of time during installation**. A pre-assembly in the workshop optimizes the logistics and handling of the cladding elements on site.

Its **Single Hook technology** extends its field of application to **double skins and interior and exterior facades**.

VARIANCE P IS COMPATIBLE with all types of geometry, **symmetrical and asymmetrical**, horizontal or vertical grids and all types of support and framing, including wood frames.



DOWNLOAD
the brochure



THE VARIANCE P® SYSTEM

HOOKS WEIGHT

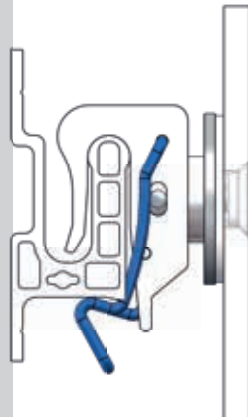

Hook system
with anti-lift clip

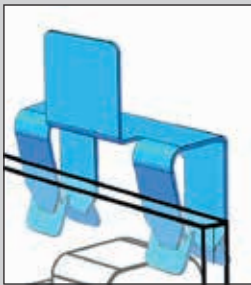
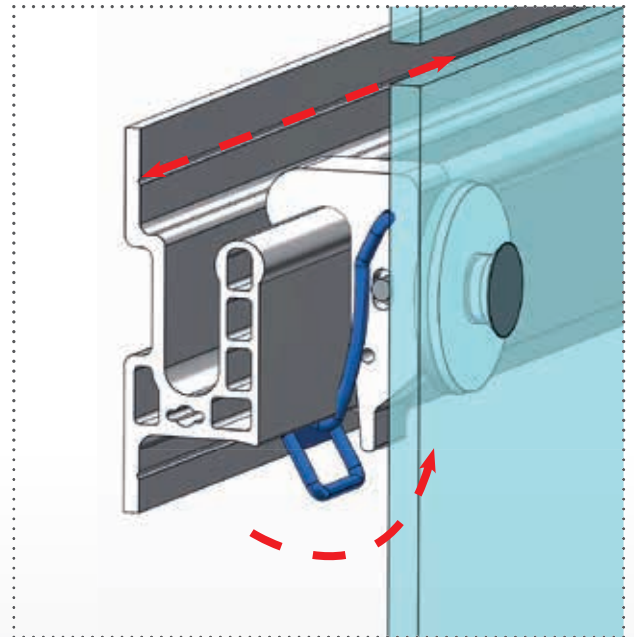

OPTION: the clip anti-translation

*(Seismic zone, negative slope,
extreme wind pressure)*

Hook system
« free point » with **anti-noise
solution to avoid any noise
pollution.**

WIND HOOKS



TECHNICAL ADVANTAGES

UNIQUE ADAPTABLE
FIXING SYSTEM

MINIMALIST HANGING
SYSTEM

LOAD DISTRIBUTION BETWEEN
ALL FASTENERS

IMPACT RESISTANCES
(UP TO Q4 LEVEL)

A system that avoids any stress in the glass!

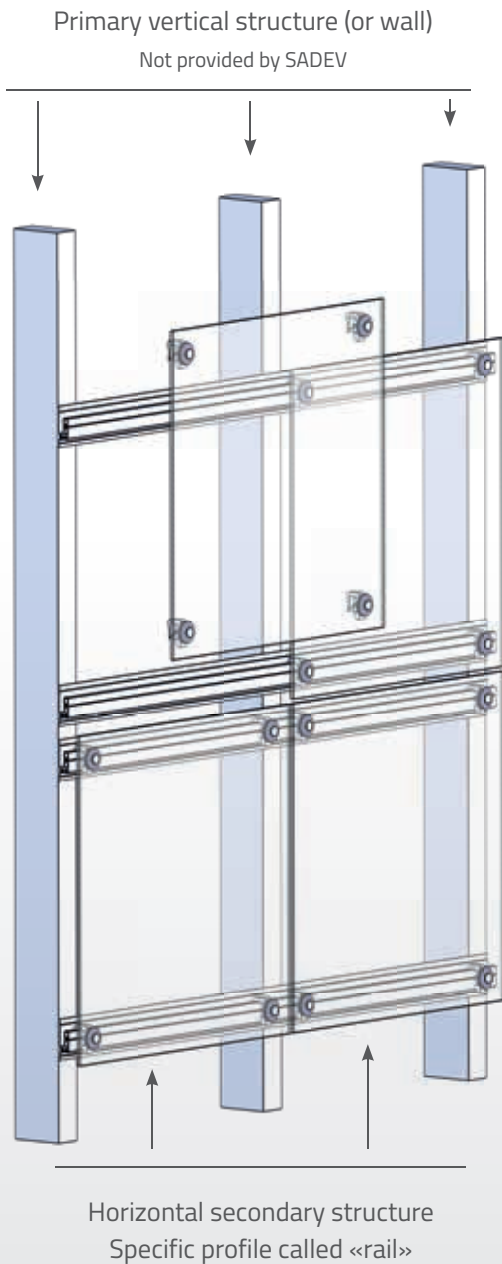

THE ADVANTAGES OF OUR SYSTEM

This fixing system allows:

- to absorb the movements of the building (including seismic movements);
- a longer life of the facade;
- the expansion joints are minimalist and not visible;
- easy maintenance in case of replacement of a cladding.

COMPATIBLE

Laminated glasses / monolithic glasses

▪ THE WEIGHT HOOKS

are load-bearing (weight-bearing).

They are hooked on the top rail and also guarantee anti-lifting.

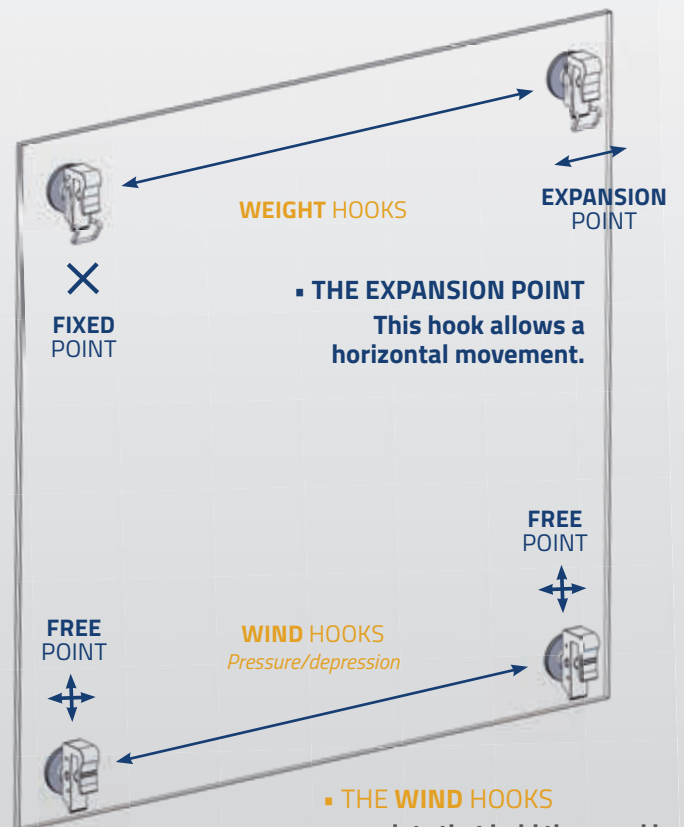

▪ THE FIXED POINT

This point is completely locked, prohibiting any movement. In this case, it is the fixed reference point.

▪ THE FREE POINTS

The hooks are longer to allow easy support and hooking during installation.

A vertical positioning gap between the rail and the hook allows for both horizontal and vertical translation of the panel (expansion).

▪ THE WIND HOOKS

are points that hold the panel in pressure/depression under the effect of the wind.



Capsule for invisible fixing
adaptable to the glass shade.



ARCHITECTURAL ADVANTAGES

FITS ALL SHAPES AND INCLINATIONS OF WALLS,
FROM VERTICAL TO OVERHANGS
AND CEILING RETURNS

USE OF A MULTITUDE OF CLADDINGS
ON THE SAME FRAME

INVISIBLES FIXINGS

WIDE CHOICE OF COLORS,
DESIGNS AND PRINTS

INSTALLATION ON NEW CONSTRUCTION
OR RENOVATION





A NEW BROCHURE

NEW



TECHNICAL ADVICE



NEW

CC
FAT

**AVIS
TECHNIQUE**

OSF

N°2.1-22-1830-V1

FDES



NEW

VIDEOS



NEW



SCAN ME
to find the the latest news

OPTIMAL, SIMPLE, FLEXIBLE... AND ECOLOGICAL!

O PTIMAL

BY ITS **PRICE**

BY ITS **COMPACTNESS**

BY ITS **PERFORMANCE**

S IMPLE

TO ORDER

TO STORE

TO INSTALL

F LEXIBLE

BY ITS **TYPES OF MOUNTINGS**

BY ITS **SUPPORTS**

BY ITS **APPLICATIONS**



Packaging &
recyclable product

Our wedges are made
with **100% recycled ABS plastic**
(*Acrylonitrile Butadiène Styène*).

At each end of life of our holds,
this material is recovered and mixed
with virgin ABS to make new products.



Our patented
systems are
made in France.

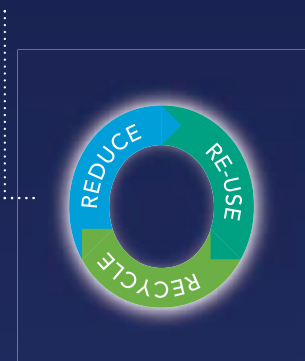

SUSTAINABLE, a priority

Our products are designed
to be sustainable, not only through
their performance but also through
the **choice of materials used**.

From 62 euros* per linear meter

for private application with 6.6 glass (price excluding glass),
under technical advice

You think you'll find it cheaper at BATIMAT?



**THE
HANDRAILS**

**A complete range
for a perfect finish!**



**ACCESSORIES
& TOOLS**

**The tools for an
ultra fast and easy
installation and a
perfect alignment!**



Double
leveling

**LEVELING
TOOL**



An alignment of the glasses
without any dismantling!

**GLASS HEIGHT
ADJUSTMENT
WEDGE**



For perfect
connections

CONNECTOR 90°

*BATIMAT operation: offer valid for 30 days, starting October 3, 2022.



A NEW 2022-2023 CATALOG



TECHNICAL ADVICE

FDES

NEW



NEW

VIDEOS

NEW



SCAN ME
to find the the latest news

PRIVATE APPLICATION

The only product on the market under technical advice for private application, validated in 6.6.2 tempered PVB

Glasses: 11.5 > 25.52mm



PUBLIC APPLICATION

Best versatility/performance/price ratio
Permanent stock of 20 km of guardrails in France

Glasses: 11.5 > 25.52mm



STADIUM APPLICATION

High performance profiles, validated for stadium application

Glasses: 19 > 34mm

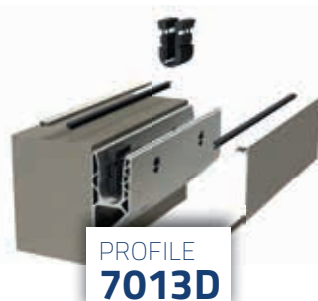

WEDGES
**ONE SIDE
& DOUBLE SIDE**

Wedges for all sizes
for all glass sizes.

The easiest wedges to fix and remove!
Mechanical clamping = high performance!
Leveling system with self-adjustment of the glass
(+ or - 15mm): innovation and SADEV patent



WEDGE ONE SIDE

▶ Access
on one side only
of the profile



WEDGE DOUBLE SIDE

▶ Access
on both sides
of the profile

ACCESSORIES
& TOOLS

The 4th dimension
accessories for a quick
and easy installation in all
dimensions!

LIVE ASSEMBLY
on our stand

SABCO
4 DIMENSIONS



Double
leveling

LEVELING
TOOL

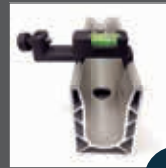

Advantage n°1

It clips on!

Leveling the profile
is now a breeze.



Advantage n°2

It has a double leveling feature!
Simply clip on two levelling tools
spaced as far apart as possible,
according to the length of the level
being used.



To level
the profile

SHIMS



Perfect alignment without
disassembling!

GLASS HEIGHT
ADJUSTMENT
WEDGE



With this wedge,
there is no need
to shim your
glass to adjust
the height.

A PERFECT ALIGNMENT!

WITH ADJUSTING WEDGE

WITHOUT ADJUSTING WEDGE

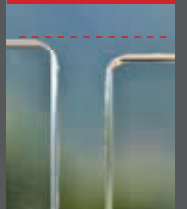

THE
HANDRAILS

Wide range available:
- In all shapes
- In all materials
- For all applications!

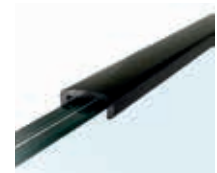



We Build the Invisible

CLASSIC[®]

DECOR[®]

CONSTRUCT[®]

SABCO[®]

SWIMSIDE[®]

Member of
**SIMONSWERK
GROUP**

Tel. +33(0) 4 50 08 39 00 | Fax. +33(0) 4 50 08 39 49
76, chemin des Poses - 74330 Poisy (France)

sadev.com
follow us on

