

SYNTHÉSIS

Le système Synthesis vous séduira par son design original aux courbes douces et raffinées. Il s'intègre très bien dans un environnement moderne, voir contemporain. Le rail est percé et fixé par l'arrière sur verre ou mur.

The Synthesis system will seduce you with its smooth and sophisticated curves. Its design is adapted for modern and contemporary environments. The track is drilled and attached from the rear on the wall or the glass.

FICHES TECHNIQUES SUR sadev.com
TECHNICAL INFORMATION ON sadev.com



APPLICATION SUR MUR / WALL APPLICATION

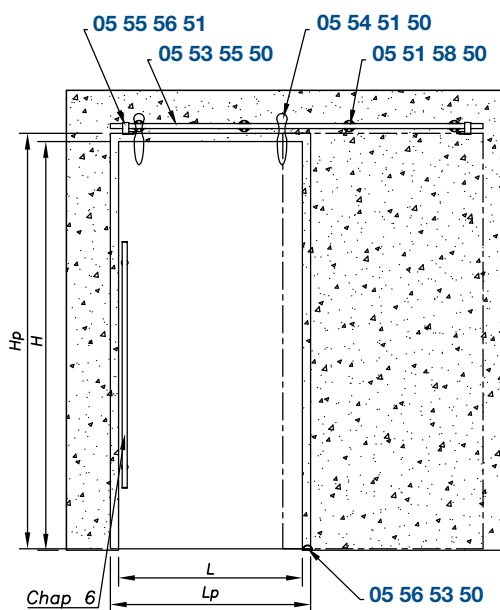

APPLICATION SUR VERRE / GLASS APPLICATION

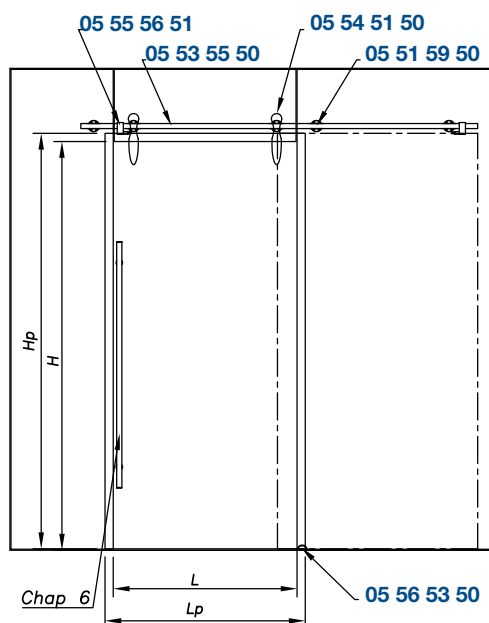
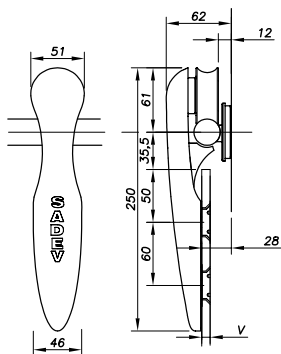
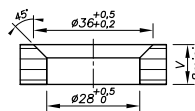

PHOTO PHOTO	ENCOMBREMENT DIMENSIONS	EPAISSEUR DE VERRE GLASS THICKNESS	PERÇAGE DU VERRE GLASS DRILLING	RÉFÉRENCE REFERENCE
----------------	----------------------------	---------------------------------------	------------------------------------	------------------------

Chariot de coulissant Synthesis / Synthesis sliding door carriage



8 → 12 mm



05 54 51 50 06 11 12

Autres épaisseurs de verre sur demande / Other glass thicknesses on order
Plus d'informations techniques sur sadev.com / More informations on sadev.com

i FICHES TECHNIQUES SUR sadev.com
TECHNICAL INFORMATION ON sadev.com

DÉTAILS DES COMPOSANTS
COMPONENTS DETAILS

PHOTO PHOTO	ENCOMBREMENT DIMENSIONS	RÉFÉRENCE REFERENCE
Fixation de rail par l'arrière sur mur / Track attachment from the rear on the wall		

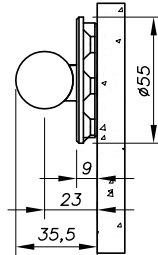

05 51 58 50*

PHOTO PHOTO	ENCOMBREMENT DIMENSIONS	EPAISSEUR DE VERRE GLASS THICKNESS	PERÇAGE DU VERRE GLASS DRILLING	RÉFÉRENCE REFERENCE
Fixation de rail par l'arrière sur verre / Track attachment from the rear on glass				

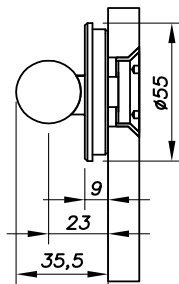

8 mm

05 51 59 50 07 11 08*

10 mm

05 51 59 50 07 11 10*

12 mm

05 51 59 50 07 11 12*

13,52 mm

05 51 59 50 07 11 14**

15,52 mm

05 51 59 50 07 11 16**

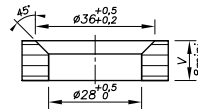

* Disponible en inox 316 sur demande / Available in 316 stainless steel on demand.
** Seulement pour les systèmes Strong & Medium / Only for Strong & Medium systems.

PHOTO PHOTO	ENCOMBREMENT DIMENSIONS	RÉFÉRENCE REFERENCE
Fixation de rail par pince sur mur / Track attachment on wall by clamp		

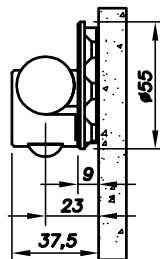

05 52 58 50

Autres épaisseurs de verre sur demande / Other glass thicknesses on order
Plus d'informations techniques sur sadev.com / More informations on sadev.com

DÉTAILS DES COMPOSANTS
COMPONENTS DETAILS



FICHES TECHNIQUES SUR
sadev.com
TECHNICAL INFORMATION ON
sadev.com

PHOTO PHOTO	ENCOMBREMENT DIMENSIONS	EPAISSEUR DE VERRE GLASS THICKNESS	PERÇAGE DU VERRE GLASS DRILLING	RÉFÉRENCE REFERENCE
----------------	----------------------------	---------------------------------------	------------------------------------	------------------------

Fixation de rail par pince sur verre / Track attachment on glass by clamp

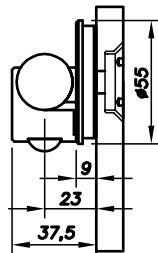

8 mm

05 52 59 50 07 11 08

10 mm

05 52 59 50 07 11 10

12 mm

05 52 59 50 07 11 12

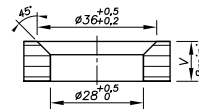
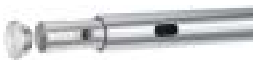

PHOTO PHOTO	LONGUEUR LONGUEUR	RÉFÉRENCE REFERENCE
----------------	----------------------	------------------------

Rail ø25 percé / Drilled ø25 track



Sur-mesure (Distance maxi des entraxes: 730 mm)
On demand (Max distance between the points : 730 mm)

05 53 55 50 -X*

PHOTO PHOTO	LONGUEUR LONGUEUR	RÉFÉRENCE REFERENCE
----------------	----------------------	------------------------

Rail ø25 non percé / Non-drilled ø25 track



Sur-mesure (Distance maxi des entraxes: 730 mm)
On demand (Max distance between the points : 730 mm)

05 52 55 50 -X*

* Avec X longueur rail en mm / With X track length in mm.

PHOTO PHOTO	LONGUEUR LONGUEUR	RÉFÉRENCE REFERENCE
----------------	----------------------	------------------------

Rail de guidage pour porte bois / Guide track for wooden door

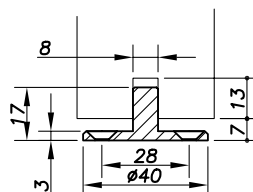
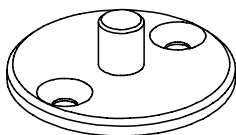

05 55 56 55

Autres épaisseurs de verre sur demande / Other glass thicknesses on order
Plus d'informations techniques sur sadev.com / More informations on sadev.com

i FICHES TECHNIQUES SUR sadev.com
TECHNICAL INFORMATION ON sadev.com

DÉTAILS DES COMPOSANTS
COMPONENTS DETAILS

PHOTO PHOTO	ENCOMBREMENT DIMENSIONS	RÉFÉRENCE REFERENCE
	Connecteur de rail $\varnothing 25$ / Track connection sleeve $\varnothing 25$	

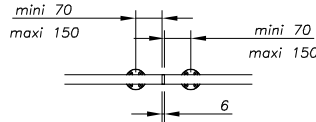

05 54 55 50

PHOTO PHOTO	ENCOMBREMENT DIMENSIONS	MODÈLE MODEL	RÉFÉRENCE REFERENCE
	Butée de rail hydraulique / Hydraulic door stop		

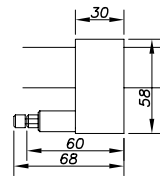

Droite
Right

05 55 56 51 D*

Gauche
Left

05 55 56 51 G*

* Disponible en inox 316 sur demande / Available in 316 stainless steel on demand.

PHOTO PHOTO	ENCOMBREMENT DIMENSIONS	MODÈLE MODEL	RÉFÉRENCE REFERENCE
	Butée de rail standard / Standard door stop		

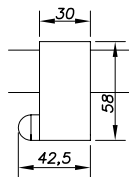

Droite
Right

05 55 56 52 D

Gauche
Left

05 55 56 52 G

PHOTO PHOTO	ENCOMBREMENT DIMENSIONS	RÉFÉRENCE REFERENCE
	Butée de porte direct / Direct door stop	

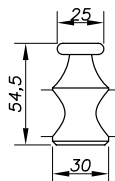

05 60 51 55

Autres épaisseurs de verre sur demande / Other glass thicknesses on order
Plus d'informations techniques sur sadev.com / More informations on sadev.com

DÉTAILS DES COMPOSANTS
COMPONENTS DETAILS

FICHES TECHNIQUES SUR
sadev.com
TECHNICAL INFORMATION ON
sadev.com

PHOTO PHOTO	ENCOMBREMENT DIMENSIONS	RÉFÉRENCE REFERENCE
Manchon de connexion sur mur / Wall connection sleeve		

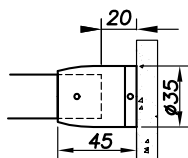

05 55 57 50

PHOTO PHOTO	ENCOMBREMENT DIMENSIONS	PERÇAGE DU VERRE GLASS DRILLING	EPAISSEUR DE VERRE GLASS THICKNESS	RÉFÉRENCE REFERENCE
Manchon de connexion sur verre / Glass connection sleeve				

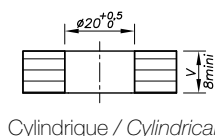
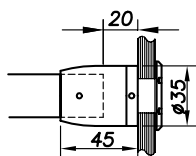

Cylindrique / Cylindrical

8 → 12 mm

05 55 57 50 - V*

13,52 → 15,52 mm

05 55 57 50 - V2*

* Disponible en inox 316 sur demande / Available in 316 stainless steel on demand.

PHOTO PHOTO	ENCOMBREMENT DIMENSIONS	EPAISSEUR DE VERRE GLASS THICKNESS	RÉFÉRENCE REFERENCE
Rail de guidage au sol / Floor guide track			

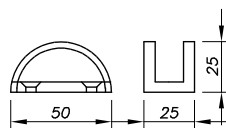

8 mm

05 56 53 50*

10 mm

05 56 53 51*

12 mm

05 56 53 52*

15 mm

05 56 53 54**

* Disponible en inox 316 sur demande / Available in 316 stainless steel on demand.

** Seulement pour les systèmes Strong / Only for Strong systems.

Autres épaisseurs de verre sur demande / Other glass thicknesses on order

Plus d'informations techniques sur sadev.com / More informations on sadev.com

i FICHES TECHNIQUES SUR sadev.com
TECHNICAL INFORMATION ON sadev.com

PHOTO PHOTO	ENCOMBREMENT DIMENSIONS	PERÇAGE DU VERRE GLASS DRILLING	EPAISSEUR DE VERRE GLASS THICKNESS	RÉFÉRENCE REFERENCE
	Chariot de coulisant Strong télescopique avec anti-dégondage intégré Strong telescopic sliding carriage with anti-jump device			

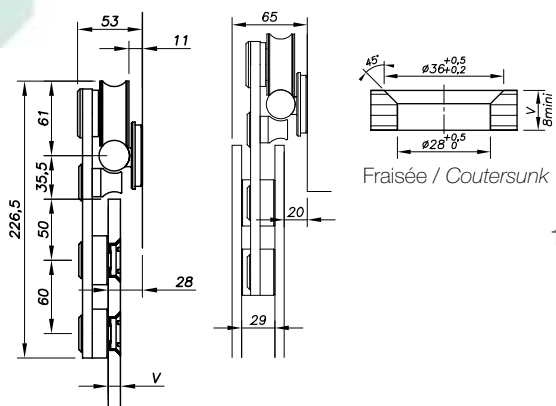

8 → 12 mm **05 51 51 60 06 11 20**

13,52 → 15,52 mm **05 51 51 60 06 11 24**

PHOTO PHOTO	ENCOMBREMENT DIMENSIONS	RÉFÉRENCE REFERENCE
	Equerre de fixation de rail au plafond en L / Square for fixing the track to a L-shaped ceiling	

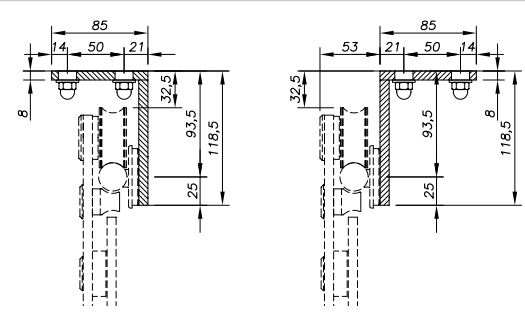

05 50 59 28

PHOTO PHOTO	ENCOMBREMENT DIMENSIONS	RÉFÉRENCE REFERENCE
	Equerre de fixation de rail en T / Square for fixing the track to a T-shaped ceiling	

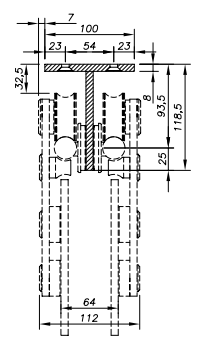

05 50 59 30

Autres épaisseurs de verre sur demande / Other glass thicknesses on order
Plus d'informations techniques sur sadev.com / More informations on sadev.com

**ACCESSOIRES
ACCESSORIES**

i FICHES TECHNIQUES SUR sadev.com
TECHNICAL INFORMATION ON sadev.com

PHOTO PHOTO	ENCOMBREMENT DIMENSIONS	RÉFÉRENCE REFERENCE
	Connecteur tube à angle ajustable / Adjustable angle track-to-track connector	

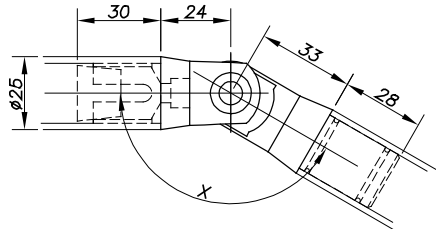

07 05 02 21 50

	Connecteur tube à tube fixe 90° / Fixed 90° track-to-track connector	
--	--	--

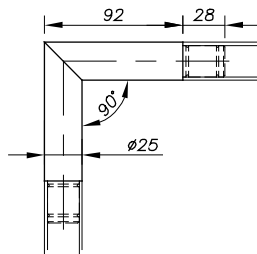

07 05 02 29 50

PHOTO PHOTO	ENCOMBREMENT DIMENSIONS	RÉFÉRENCE REFERENCE
	Antichoc de porte double au sol / Dual door anti-shock on floor	

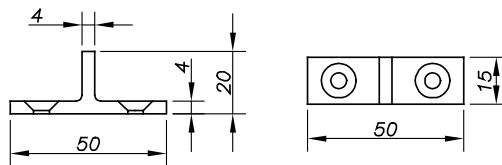

05 56 54 50

PHOTO PHOTO	ENCOMBREMENT DIMENSIONS	PERÇAGE DU VERRE GLASS DRILLING	EPAISSEUR DE VERRE GLASS THICKNESS	RÉFÉRENCE REFERENCE
	Antichoc de porte double sur porte / Dual door anti-shock on door			

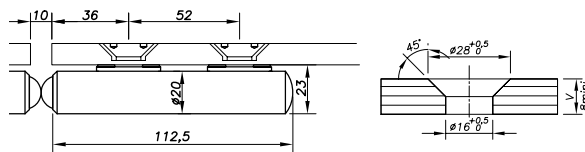

8 → 12 mm

05 56 54 52

Autres épaisseurs de verre sur demande / Other glass thicknesses on order
Plus d'informations techniques sur sadev.com / More informations on sadev.com