

FLOOR MOUNTING

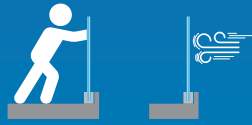

PROFILE 7019



TESTED & APPROVED



All the elements compatible with the **7019 PROFILE** can be found in this section

WEDGES, CLADDINGS & ACCESSORIES > p.96

THICKNESS OF GLASS
12 > 25.52 mm



APPLICATION | **RESIDENTIAL** | **PUBLIC** | **STADIUM**

COMPATIBILITY OF WEDGES
One Side & Double Side



POSSIBLE FINISHES



00
Raw
aluminum



01
Anodized
aluminum

ADJUSTMENT OF GLASS
+ or - 15 mm



sadev.com



BIM
PRODUCT

► Reference **0070RAIL19**

TYPE OF USE

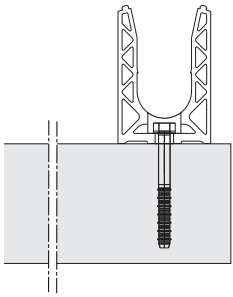

FLOOR MOUNTING

DIFFERENT SPECIFICITIES

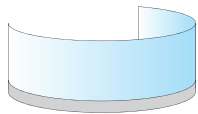

CURVED

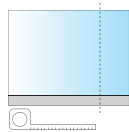

MADE TO MEASURE

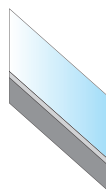

INCLINE



HIGH LEVEL

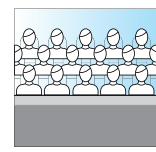

HIGH PERFORMANCE

TECHNICAL SPECIFICATION AND INTERNATIONAL CERTIFICATION

Solutions tested according to regulations of different countries  can be found in the country performance guide.

FLOOR MOUNTING PROFILE 7019



THICKNESS OF GLASS
12 > 25.25 mm

► Reference **0070RAIL19**

TESTED & APPROVED



HIGH
PERFORMANCE

Application **STADIUM
C5 / UEFA**

In 12.12 SGP

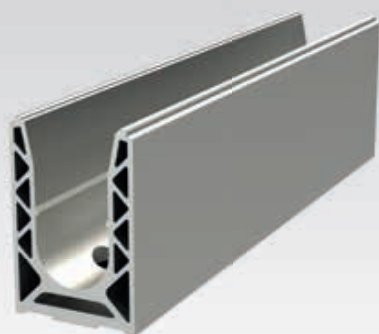

TECHNICAL CHARACTERISTICS

Length	2 500 mm / 5 000 mm
Width	75 mm
Height of profile	112 mm
Material	Aluminum
Type of application	Residential / public / Stadium
Type of mounting	Floor
Thickness of glass	12 > 25.52 mm
Height of guardrail	Standard: 2 100 mm
Profile finish	Anodized aluminum ,raw
Fixing the profile	Every 150 mm

**FOR MORE INFORMATION
ON ANCHORING THE PROFILE:**
see our country performance guide
or the Technical Advice for each profile.

